

XTP601

Process Oxygen Analyzer

User Manual



97313 Issue 8.3
November 2021
(For use with firmware V1.11)

Please fill out the form(s) below for each instrument that has been purchased.

Use this information when contacting Michell Instruments for service purposes.

Product Name	
Order Code	
Serial Number	
Invoice Date	
Installation Location	
Tag Number	

Product Name	
Order Code	
Serial Number	
Invoice Date	
Installation Location	
Tag Number	

Product Name	
Order Code	
Serial Number	
Invoice Date	
Installation Location	
Tag Number	



XTP601

For Michell Instruments' contact information please go to
www.michell.com

© 2021 Michell Instruments

This document is the property of Michell Instruments Ltd and may not be copied or otherwise reproduced, communicated in any way to third parties, nor stored in any Data Processing System without the express written authorization of Michell Instruments Ltd.

Contents

Safety	vii
Electrical Safety	vii
Pressure Safety	vii
Temperature Safety	vii
Toxic Materials	vii
Repair and Maintenance	vii
Calibration	vii
Safety Conformity	vii
Equipment Ratings	vii
Abbreviations	viii
Warnings	viii
1 INTRODUCTION	1
1.1 Features	2
1.2 Applications	3
1.3 O-Ring Selection	3
2 OPERATION	4
2.1 Preparation	4
2.2 Powering up the Analyzer	5
2.3 User Interface	6
2.3.1 Interface Controls	6
2.3.2 'ESC' Button	7
2.3.3 'Up/Down Arrow' Buttons	7
2.3.4 'ENTER' Button	7
2.4 Menu Structure	8
2.4.1 Changing the Passcode	8
2.4.2 Menu Map	9
2.5 Front Pages (No passcode Required)	9
2.5.1 Front Page	10
2.5.2 Chart Page	11
2.5.3 Secondary Parameters Page	12
2.5.4 O ₂ Min/Max Page	12
2.5.5 Alarms Log Pages	13
2.6 Info Page	13
2.7 Main Menu (Passcode Required)	14
2.7.1 Settings Page	15
2.7.2 Human Machine Interface (HMI) Page	16
2.7.3 Reset Page	17
2.7.4 Alarms Page	18
2.7.5 External Compensation Page	19
2.7.6 External Sensor Page	20
2.7.7 Outputs Page	21
2.7.8 Field Cal Page	22
2.7.9 Light Guide Option	22
3 CALIBRATION	23
3.1 1-Point Calibration	24
3.2 2-Point Calibration	25
3.3 Field Calibration Reset	26
4 INSTALLATION	27
4.1 Unpacking	28
4.2 System Components	29

4.3	Set-Up.....	30
4.4	Mechanical Installation.....	31
4.4.1	Gas Connection.....	31
4.4.2	Sample Gas Requirements	31
4.4.3	Calibration Gases	32
4.5	Electrical Installation.....	32
4.5.1	Power Supply and Input/Output Signal	32
4.5.2	Power Supply (PL9 – Green)	33
4.5.3	Signal Output	33
4.5.4	Serial Output	33
4.5.5	Analog (4...20 mA) Outputs and Communications (PL5 – Green)	34
4.5.6	Alarm Relay Contacts (PL1 – Black)	34
4.5.7	Analog (4...20 mA) Inputs and Sensor Excitation Voltage (PL4 – Green).....	35
4.5.8	Light Guide.....	35

Figures

Figure 1	XTP601 Oxygen Analyzer Versions	1
Figure 2	Initializing Screen	5
Figure 3	Main Page.....	5
Figure 4	User Interface	6
Figure 5	XTP600 Series Application Software	6
Figure 6	ESC Button	7
Figure 7	Up/Down Arrow Buttons	7
Figure 8	ENTER Button	7
Figure 9	Menu Map.....	9
Figure 10	Front Page.....	10
Figure 11	Chart Page.....	11
Figure 12	Secondary Parameters Page	12
Figure 13	O ₂ Min/Max Page	12
Figure 14	Alarms Log Page	13
Figure 15	Info Page.....	13
Figure 16	User Set-Up Variables Page	14
Figure 17	Settings Page	15
Figure 18	HMI Page.....	16
Figure 19	Date and Time Page	16
Figure 20	Reset Page.....	17
Figure 21	Alarms Page.....	18
Figure 22	External Compensation Page	19
Figure 23	External Sensor Page.....	20
Figure 24	OUTPUTS Page	21
Figure 25	NAMUR ERR Page.....	21
Figure 26	Field Cal Page	22
Figure 27	1-Point Calibration Page	24
Figure 28	2-Point Calibration Page	25
Figure 29	Field Calibration Reset Page	26
Figure 30	XTP601 Cutaway Showing Major Components	29
Figure 31	XTP601 Lid Removal	30
Figure 32	XTP601 Cable Entries.....	31
Figure 33	Terminal Block Locations.....	32
Figure 34	XTP601 Dimensional Drawings	39

Appendices

Appendix A	Technical Specifications.....	37
A.1	Dimensions Ex version	39
Appendix B	Modbus Register Map	41
Appendix C	Hazardous Area Certification	47
C.1	Product Standards	47
C.2	Product Standards	47
C.3	Global Certificates/Approvals	47
C.4	Special Conditions.....	48
C.5	Maintenance and Installation	48
Appendix D	Quality, Recycling, Compliance & Warranty Information.....	50
Appendix E	Analyzer Return Document & Decontamination Declaration	52

Safety

The manufacturer has designed this equipment to be safe when operated using the procedures detailed in this manual. The user must not use this equipment for any other purpose than that stated. Do not apply values greater than the maximum value stated.

This manual contains operating and safety instructions, which must be followed to ensure the safe operation and to maintain the equipment in a safe condition. The safety instructions are either warnings or cautions issued to protect the user and the equipment from injury or damage. Use qualified personnel and good engineering practice for all procedures in this manual.

Electrical Safety

The instrument is designed to be completely safe when used with options and accessories supplied by the manufacturer for use with the instrument. The input power supply voltage is 24 V DC, 1.5 A (max). Refer to labels on the instrument or calibration certificate.

Pressure Safety

DO NOT permit pressures greater than the safe working pressure to be applied to the instrument. The specified safe working pressure for this instrument is 3 barg (43 psig) max.

Temperature Safety

During operation some parts of the instrument may be at high temperature.

Toxic Materials

The use of hazardous materials in the construction of this instrument has been minimized. During normal operation it is not possible for the user to come into contact with any hazardous substance which might be employed in the construction of the instrument. Care should, however, be exercised during maintenance and the disposal of certain parts.

Long exposure to, or breathing of the calibration gases, may be dangerous.

Repair and Maintenance

The instrument must be maintained either by the manufacturer or an accredited service agent. For Michell Instruments' worldwide offices contact information go to www.michell.com.

Calibration

The recommended calibration interval for the analyzer is 3 months. Depending on the application in which the instrument is used, the calibration interval may be reduced. Please consult the factory for the specific calibration interval.

Safety Conformity

This product carries the CE/UKCA mark and meets the requirements of relevant European safety directives.

Equipment Ratings

This equipment must be supplied with a voltage of 24 V DC, 1.5 A (36 W).

The power is connected via PL9 on the mother board (see Section 4.5).

All input and output connectors are 2-part pcb mounted type.

The detachable, screw terminal half of each connector is designed to accept 24 -12 AWG stranded or solid conductors.

Abbreviations

The following abbreviations are used in this manual:

A	Ampere
AC	alternating current
bara	pressure in bar (absolute)
barg	pressure in bar (gauge)
°C	degrees Celsius
°F	degrees Fahrenheit
DC	direct current
kg	kilogram
kPa	Kilopascal
lb	pound
max	maximum
mA	milliampere
ml/min	milliliters per minute
mm	millimeters
ppm	parts per million
psig	pounds per square inch
scfh	standard cubic feet per hour
V	Volt
"	inches
Ω	ohm

Warnings

The following general warnings listed below are applicable to this instrument. They are repeated in the text in the appropriate locations.



Where this symbol appears in the following sections it is used to indicate areas where potentially hazardous operations need to be carried out. THESE TASKS SHOULD BE UNDERTAKEN BY QUALIFIED PERSONNEL ONLY.



Where this symbol appears in the following sections it is used to indicate areas of potential risk of electric shock.

NOTE: Warnings and important notifications are marked with bold text.

1 INTRODUCTION

This manual will show how to measure oxygen easily using the XTP601 Oxygen Analyzer.

The following sections contain information about:

- Analyzer components
- Operating instructions
- Calibration and maintenance of the Analyzer
- Installation

Please read this manual carefully and pay special attention to the safety warnings and notifications.

NOTE: Warnings and important notifications are marked with bold text.

The 3 versions of the XTP601 available are shown below:



Figure 1 XTP601 Oxygen Analyzer Versions

The XTP601 Oxygen Analyzer is based on Michell Instruments' advanced proprietary Thermo-Paramagnetic technology. It measures the percentage of oxygen in a wide range of gases, including nitrogen, hydrogen, carbon dioxide methane and biogas. The sensor is housed in a weather-proof (GP version) or explosion-proof (EX version) casing – both IP66 & NEMA 4X rated. It is suitable for a range of applications in safe or hazardous areas.

EX1 and GP2 models are supplied with flame arrestors for use with flammable gases or in hazardous areas.

NOTE: this manual relates to products with firmware version V1.11

1.1 Features

- The XTP601 can be supplied meeting the requirements of IEC 61508 SIL2, allowing the user to integrate the analyzer into their functional safety system.
- There are 2 versions of the XTP601 available:
 - General Purpose Analyzer with touch screen (capacitive buttons)
 - Hazardous Area version of above with flame arrestors
- The XTP601 is calibrated in a specific background gas to match customer's requirements. This is displayed on the front screen of the analyzer or via the Application Software.
- The XTP601 provides 2 off 4...20 mA analog output signals that are proportional to the oxygen concentration. The primary 4...20 mA output is locked on the calibrated range of the instrument. The secondary output is user-selectable within the calibrated range.
- Modbus RTU over RS485 serial communications are provided as standard.
- Accuracy of 1% of reading or 0.02% O₂, whichever is greater. (Zero suppressed ranges ±0.2% O₂).
- Zero and span stability of 0.25% of span per month.
- The innovative Thermo-Paramagnetic sensor design used in the XTP601 Oxygen Analyzer has no moving parts. This makes it less sensitive to vibration and movement and highly resistant to drift over a long period of time, compared to other sensing technologies, and it offers increased protection against contamination.
- The robust and weather-proof enclosure (IP66 rated) allows the XTP601 to be installed on-site, at the point of measurement. It is also available with an explosion-proof casing.
- Low cost of ownership due to minimal maintenance. For installation and commissioning, the casing unscrews to allow for easy access to the electrical connections.
- The XTP601 is certified to ATEX, IECEX, UKCA, cQPSus & TR CU Ex for use in hazardous areas.
- 2 x single pole change-over relay alarms for oxygen concentration, supplied as standard. Can be configured as OFF, LOW or HIGH.

1.2 Applications

The XTP601 has a robust sensor with high sensitivity and stability. It can be factory-calibrated in varying backgrounds to match the customer's process gas.

Together with the purpose-designed sampling system, the XTP601 is able to work under various process and environmental conditions. Examples of applications include:

- Oxygen generator monitoring inert blanketing gases
- Oxygen measurement at inlet of compressors in steel or gas industries for safety
- Biogas, waste, landfill and digester plants
- Inert gas monitoring for pharmaceutical industry

1.3 O-Ring Selection

The XTP601 is available with 3 types of O-rings to offer greater flexibility with material compatibility. The Viton O-ring is fitted as standard. The EKRAZ O-ring is available for solvent resistance. For extremely low temperatures there is a closed cell Silicone O-ring.

To comply with Hazardous Area certification, the material used in the EX1 version is dependent on the lowest ambient temperature of the area the units are to be transported, stored or installed in:

Ambient operating range:

+5 °C...+60 °C (41 °F...+140 °F)

Ambient range for storage and transportation:

-40 °C...+60 °C (-40 °F...+140 °F) (for Silicone version)

-15 °C...+60 °C (5 °F...+140 °F) (for Viton version) – Standard

-10 °C...+60 °C (14 °F...+140 °F) (for Ekraz version)

NOTE: Silicone O-ring is not suitable for oxygen-enriched samples, i.e. O₂ > 21%.

2 OPERATION



The XTP601 is not certified for use with ambient oxygen levels that are enriched (i.e. over 21% O₂)

This analyzer has been manufactured within our quality procedures and is configured according to the purchase order. When it is installed and used as per the manufacturer's guidelines, it will operate within the stated specification.

Before starting operation it is recommended that the user becomes familiar with this manual in which all the equipment controls, indicators, the elements of the display and the overall menu structure are described.

2.1 Preparation



Before applying power and beginning the flow of gas, please ensure that the system has been properly installed following the instructions in Section 4.

Check that the wiring has been completed correctly.

Zero and Span gas cylinders with correct regulation and flow control should be in place before installing and powering up the analyzer. Commissioning should include a check with both gases and, if necessary, a field calibration performed.

The factory calibration is performed at nominally 300 ml/min with an atmospheric vent (50-100 mbarg back-pressure). The calibration gas applied to the analyzer should be at the same temperature, pressure and flow rate as the process gas being sampled.

Sample Pressure:

0.75 to 2 BarA (11 to 29 psiA)

Sample Flow Rate:

GP1 models: 100 to 500 ml/min (0.25 to 1.0 scfh)

EX1 & GP2 Models: 270 to 330ml/min (0.57 to 0.7 scfh)

2.2 Powering up the Analyzer



After all the preparation work is done and the installation and wiring have been checked, turn on the analyzer and wait for at least 30 minutes (or until **Cell T Not Stable message disappears). This will allow the analyzer to reach its operating temperature.**

There is no power switch on the XTP601 Oxygen Analyzer. It is turned on automatically once a 24 V DC power source is applied. After the analyzer is powered up, the display will be illuminated. The analyzer takes up to 5 seconds to initialize, and during this period will display the product type and firmware version number.



Figure 2 *Initializing Screen*

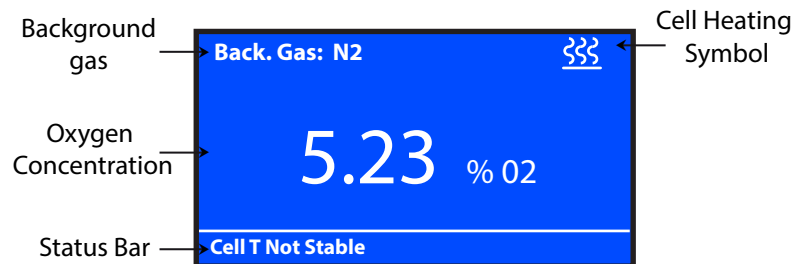

Figure 3 *Main Page*

Once initialized, the analyzer will show the Main Page which displays the O₂ concentration.

During warm-up (less than 25 minutes) a heating symbol will flash in the top right hand corner of the page. This symbol will remain until the temperature has stabilized for a minimum of 5 minutes. The analyzer will be ready for use within 30 minutes from power-up.

2.3 User Interface

2.3.1 Interface Controls

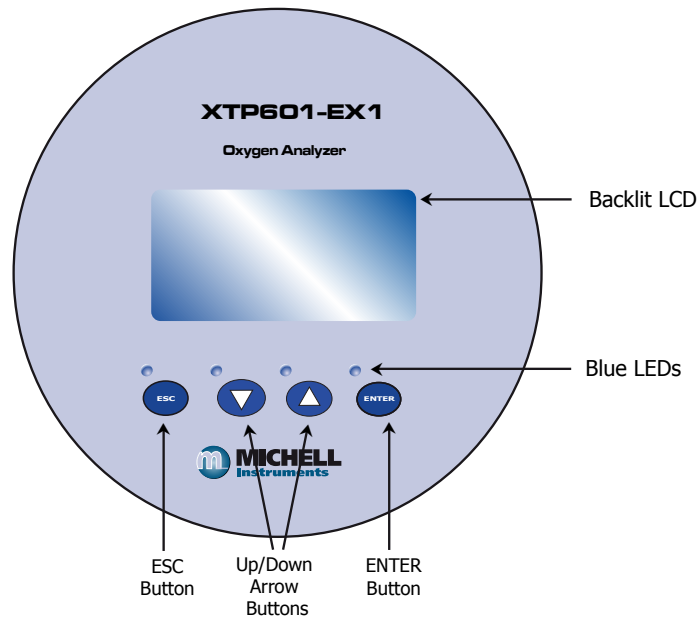

Figure 4 User Interface

The diagram above illustrates the user interface, which consists of a backlit Liquid Crystal Display and 4 touch-sensitive pads that facilitate user interaction through the glass of the enclosure.

All versions have Application Software to monitor or adjust parameters. Application software will require a PC or laptop with comm port connection. If using RS232 serial port ensure that an isolated RS232 to RS485 converter is used.

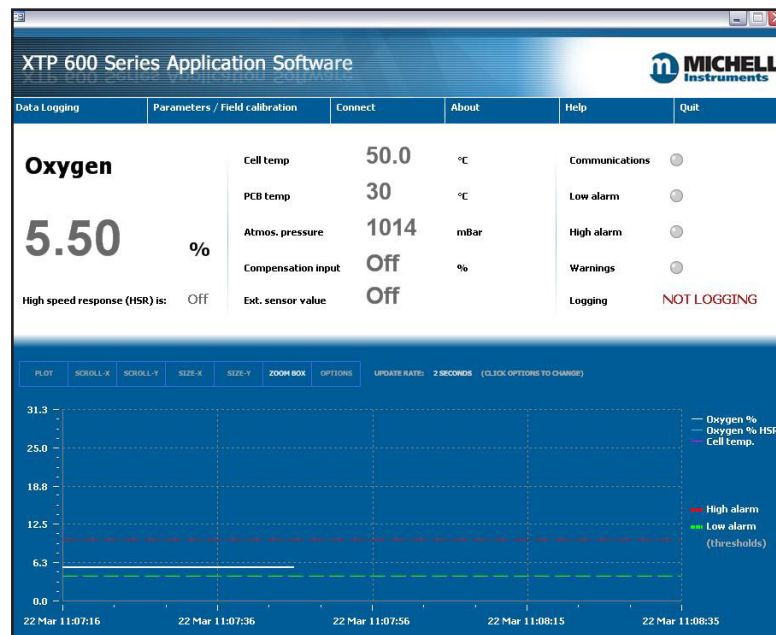

Figure 5 XTP600 Series Application Software

2.3.2 'ESC' Button



Figure 6 *ESC Button*

The **ESC** button is used to exit the current menu and to return to the previous menu. From the Main Page, pressing **ESC** will access the Info Page.

2.3.3 'Up/Down Arrow' Buttons

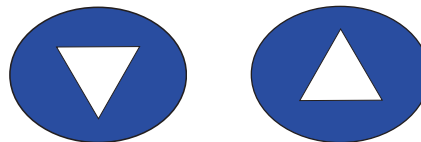

Figure 7 *Up/Down Arrow Buttons*

The **Up** (▲) and **Down** (▼) buttons are used to change pages, scroll through lists and adjust values. In the Reset and Field Calibration Menus, pressing the **Up** (▲) button 3 times will confirm a selection.

2.3.4 'ENTER' Button



Figure 8 *ENTER Button*

The **ENTER** button is used to select or de-select the highlighted item in a menu and to confirm a value. From the Main Page, pressing **ENTER** will access the Passcode Page.

2.4 Menu Structure

The XTP601 has a front page that does not require a passcode but allows the user to scroll through and view oxygen concentration, recent trend, internal parameters, minimum & maximum oxygen concentration and alarm history.

In order to change any settings on the User Menu pages, the user must enter a passcode. There is also a separate passcode for service engineers to allow factory setting changes.

To access the User Menu press the **ENTER** button from the Main Page to call up a passcode prompt. Use the **Up (▲)** and **Down (▼)** buttons and press **ENTER** after each value.

The User Passcode is: 1919

From the Main Page the user can press the **ESC** button to view the Info Page. This page shows the firmware version, hours used, last calibration date, calibration pressure and the received Modbus code.

The passcode is stored for one minute to allow access back into the User Menu, if necessary.

2.4.1 Changing the Passcode

As part of the SIL compliance the user must change the passcode after the unit is set up and before bringing it on-line in a functional safety system. This new passcode must be kept secure and must only be made available to authorized personnel.

Press **Enter** from the Front Page and arrive at the Passcode Screen.

Enter the activation code: 6182 and the unit will be ready to accept the new passcode.

Warning: The passcode can only be changed once, so care must be taken from this point onwards.

Now enter the new passcode and once activated the analyzer will bring you straight into the user menu. If you want to change your mind or you make a mistake at any point before you hit the enter button the final time, just press and hold the **ESC** button to return to the front screen and start again.

The passcode will be active for 5 minutes, so make a note of what was actually entered by going back to the passcode screen. Store this new passcode in a secure place.

If you forget/lose the passcode, contact Michell Instruments for help.

2.4.2 Menu Map

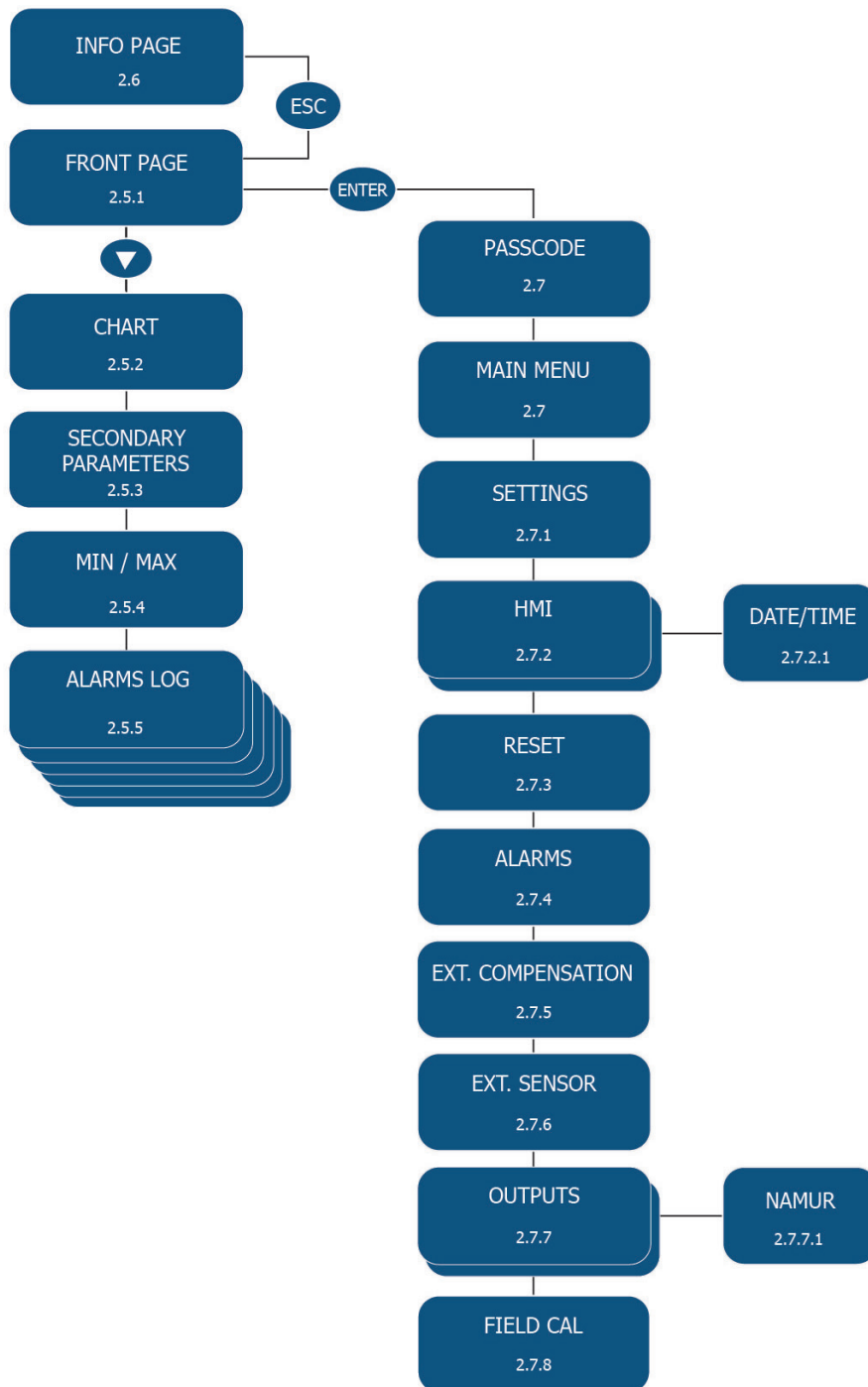

Figure 9 Menu Map

2.5 Front Pages (No passcode Required)

The EX1 and GP1 versions of the XTP601 have 5 front pages that the user can display without the need for a passcode. **NOTE: These are for display of information only and there is no way of adjusting any settings on these pages.**

From the Main Page (O₂ concentration) the rest of the front pages can be accessed using the Down (▼) button. To return to the Main Page, either press the Up (▲) button the required amount of times or press the ESC button.

2.5.1 Front Page

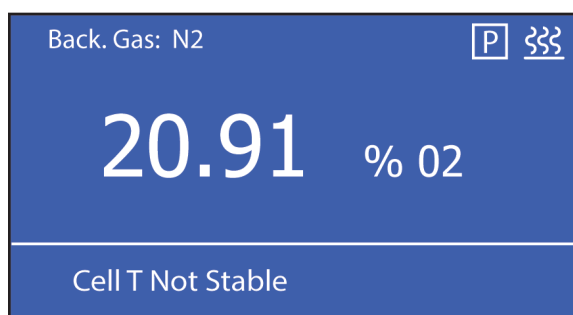

Figure 10 Front Page

Parameter	Description
Background Gas	Displays the background gas that the unit was calibrated in
% O ₂ (if HSR=OFF)	Real oxygen reading in % Display resolution = 0.01 (Display resolution 0.1% when min value is $\geq 20\%$)
% O _{2p} (if HSR = ON)	HSR oxygen reading (extrapolated quick response value of real oxygen reading) Real oxygen value is displayed in status bar
Flashing "Heating" Symbol	This flashes until cell temperature is stable at set point ± 0.5 °C for minimum of 5 minutes
Pressure Compensation	If 'P' is visible this indicates that the pressure compensation is turned on
Status Bar	Flashes any system warnings and error messages (see below)

Status Message Table	
Message (Trigger Condition)	Light Guide (if fitted)
% O ₂ out of range (beyond calibration range, e.g. 0-25%)	N/A
AL1 ON	ORANGE1 ON (app s/w only)
AL2 ON	ORANGE2 ON (app s/w only)
Comp i/p signal error (input < 3.6 mA or > 21 mA)	RED FLASH (priority2)
Ext sens signal error (input < 3.6 mA or > 21 mA)	RED FLASH (priority2)
Cell T not stable (not within ± 0.5 °C of set point for continuous period of 5 minutes)	RED ON (priority1)
Cell T sensor error (cell temp measures < -50 or > +80°C)	RED ON (priority1)
Press sensor error (pressure sensor < 850 or > 1100 mbar)	RED ON (priority1)
O ₂ sensor error (Vcomp < 1 or > 8191)	RED ON (priority1)
PCB temp too high (PCB temp > cell temp set point)	RED ON (priority1)

2.5.2 Chart Page

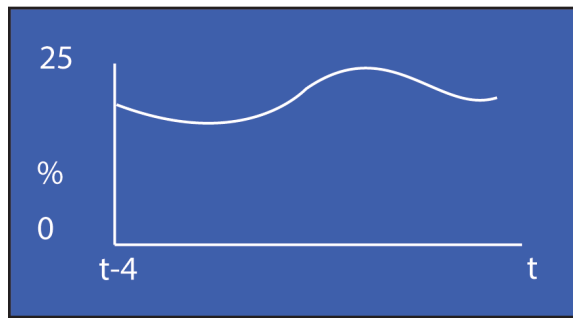

Figure 11 *Chart Page*

NOTE: This data is not available via the Modbus

- This indicative chart is continuously running at the set chart interval (2 to 60 seconds).
- Chart duration in seconds = (chart interval * 60).
- It is auto ranging with an auto range resolution of 1% O₂.
- It is reset if the chart interval is changed, the Display is changed between % O₂ and % O₂ HSR or the instrument power is cycled.
- The chart will record either % O₂ (Non HSR) or % O₂ HSR if this is set to **ON** in the setup pages.
- Chart buffer size is 60 values and therefore the chart duration changes according to interval chosen.
- Chart data is only stored in volatile memory and therefore is not saved. Chart interval is saved and available in a Modbus register.
- Chart data is not available via serial comms as the Application Software is able to perform more sophisticated charting functions.

2.5.3 Secondary Parameters Page

CELL T, °C	50.0
PCB TEMP, C	28
COMP I/P	OFF
EXT I/P	OFF

Figure 12 Secondary Parameters Page

Parameter	Description
CELL T	Sensor cell temperature display in set unit (°C, °F or Kelvin) Display Resolution = 0.1
PCB TEMP	Temperature display of Microcontroller in selected temperature unit This gives an indication of the internal GUB temperature Display Resolution = 1 unit Accuracy = ±2°C
COMP I/P	The value of compensation input (mA i/p channel 1) as a % (4 mA=0% and 20 mA=100%) OFF displayed instead of value if external compensation is turned off
EXT I/P	Value of the external input in the selected parameter and unit (DEWP, TEMPR, PRESS or NONE) OFF displayed instead of value if external compensation parameter is set to NONE

2.5.4 O₂ Min/Max Page

MINIMUM	0.00	%O ₂
D12/01	T	19:29:44
MAXIMUM	0.00	%O ₂
D12/01	T	19:29:44

Figure 13 O₂ Min/Max Page

This indicates the minimum and maximum O₂ values measured, along with date/ time of occurrence. The value is reset manually via the Reset Page in the User Menu.
NOTE: This data is not saved in NV memory and is not available via serial communications or in the blind unit.

2.5.5 Alarms Log Pages

ALARM	DATE	TIME	P1
AL1	02/01	12:50:40	
AL1	02/01	11:10:32	
AL1	02/01	11:00:29	
AL2	02/01	10:20:00	

Figure 14 Alarms Log Page

A maximum of 40 High/Low alarms, along with date and time of occurrence, are recorded in a ring buffer in NV memory. The most recent alarm will overwrite the oldest alarm when more than 40 alarms are recorded. The data is displayed over a maximum of 10 pages (with 4 alarms on each page). The latest alarm record is displayed in line 1 of page 1. This data is not available via serial communications or in the blind unit. The data is reset manually via the Reset Page in the User Menu. The data is saved and restored when the instrument is restarted. P1 = Page 1.

2.6 Info Page

Firmware Ver	1.0
Hours Used	125
Last Cal Date	04:08:11
Cal Press. mB	1000.0
Atm Press. mB	1000.0
ModBus Rx Code	---

Figure 15 Info Page

From the Main Page it is possible to get to the Info Page by pressing the ESC button.

The information available is displayed below:

Parameter	Description
Firmware Ver	Indicates the firmware version installed in the instrument
Hours used	Indicates the number of hours that the instrument has been powered up
Last Cal Date	The date of the last field or Michell Calibration Character indicates F for Field and M for Michell
Cal Press, mB	The atmospheric pressure recorded during the last calibration (used as null reference point for pressure compensation)
Atm Press, mB	Current atmospheric pressure being read within the analyzer
ModBus Rx Code	The received Modbus function code is flashed here as soon as a function code is received – this is useful to check the Modbus communications to ensure that good data is coming through. If no code is received then '---' is displayed

2.7 Main Menu (Passcode Required)

In order to change any settings on the User Menu pages, the user must enter a passcode. There is also a separate passcode for service engineers to allow factory setting changes.

To access the User Menu press the **ENTER** button from the Main Page to call up a passcode prompt. Use the **Up (▲)** and **Down (▼)** buttons and press **ENTER** after each value.

The User Passcode is: 1919

SETTINGS	EXT COMP.
HMI	EXT SENS.
RESET	OUTPUTS
ALARMS	FIELD CAL

Figure 16 *User Set-Up Variables Page*

Use the **Up (▲)** and **Down (▼)** buttons to select the sub-menu required. Then press the **ENTER** button. This will give access to one of the following pages.

2.7.1 Settings Page

FIELD CAL	ON/OFF
PRESS COMP	ON/OFF
EXT COMP	ON/OFF
HSR	ON/OFF
LIMIT 0-100%	ON/OFF
MODBUS ID	1-127

Figure 17 Settings Page

The analyzer is microprocessor-based and, as such, has settings and features accessible to the user.

Select the parameter required. The options will be highlighted and can be toggled between by pressing the **ENTER** button. These are all **ON/OFF** except for Modbus ID which, if only one analyzer is connected to your system, should be set to '1'.

Setting	Description/Operation	Options
FIELD CAL	Turns use of field calibration on or off	ON/OFF
PRESS COMP	Turns pressure compensation on or off When pressure compensation is on a P symbol will appear on the main screen	ON/OFF
EXT COMP	Turn external sensor compensation on or off	ON/OFF
HSR	Turns high speed response on or off It is automatically turned off when Michell or field calibration is being performed When HSR is ON then these values are derived from the % O ₂ HSR value: <ul style="list-style-type: none"> • mA outputs (both channels) • alarm trigger points • chart values • min/max The Main Page displayed value is also HSR value (designated % O _{2p}) The NON HSR value will also appear in the status bar	ON/OFF
LIMIT 0-100%	Limits the % O ₂ and % O _{2p} to 0.00 and 100.00% so that any drift below 0.00 and above 100.00 (for suppressed zero) is not visible mA outputs also limited accordingly	ON/OFF
Modbus ID	Unit's network address for Modbus communications	1-127

2.7.2 Human Machine Interface (HMI) Page

CONTRAST	O-100%
BRIGHTNESS	O-100%
TEMPR UNIT	C/F/K
EXT PRESS UNIT	psia, bara, kpa
CHART INTVAL	2-60s
DATE	DD/MM/YY

Figure 18 HMI Page

It is possible to change parameters within the HMI, as shown below:

Setting	Description/Operation	Options
CONTRAST	LCD contrast setting	0-100% in 10% steps
BRIGHTNESS	LCD backlit setting	0-100% in 10% steps
TEMPR UNIT	Global temperature unit selection	°C, °F, K
EXT PRESS UNIT	Pressure unit selection (for external sensor only)	psia, bara, kPa
CHART INTVAL	Chart interval	2-60 s in 2 sec steps
DATE	Date on the LCD can be either format	DD/MM/YY or MM/DD/YY

Scroll down past the DATE field to access the clock page.

2.7.2.1 Date and Time Page

HOURS	00-23
MINS	00-59
DAY	1-31
MONTH	1-12
YEAR	00-99
LIVE CLOCK	**.*.*.*

Figure 19 Date and Time Page

The real time clock and calendar is used to store date/time information for log data, min/max data and date of calibration. On entering this page all fields are initialized with the current values. These can be also be set through the application software.

Setting	Description/Operation	Options
HOURS	Hours	00-23
MINS	Minutes	00-59
DAY	Day	1-31
MONTH	Month	1-12
YEAR	Year	00-99
LIVE CLOCK	Current Time	**.*.*.*

2.7.3 Reset Page

O ₂ MIN/MAX	RESET?
ALARM LOGS	DELETE?
FIELD CAL	DELETE?

Figure 20 *Reset Page*

O₂ Min/Max and Alarm Logs can be cleared from this menu. See Sections 2.5.4 and 2.5.5 respectively for more information.

This menu can also be used to restore the original calibration settings. For more information see Section 3.3.

To reset/delete highlight the item using the **Down (▼)** button. Press **ENTER** to select the item, then press the **Up (▲)** button 3 times to confirm the change. Press **ENTER** to deselect the item.

2.7.4 Alarms Page

AL1 SETPOINT	0.00	%
AL1 CONFIG	OFF	
AL1 TEST	TOGGLE	
AL2 SETPOINT	25.00	%
AL2 CONFIG	OFF	
AL2 TEST	TOGGLE	

Figure 21 Alarms Page

The analyzer has 2 user-configurable alarms which are freely assignable within the calibrated range. The alarm relays are Single Pole Change-Over (SPCO) and are rated to 250 V, 5 A maximum. Both alarms can be set as high, low or off.

Setting	Description/Operation	Options
AL1 SETPOINT	% O ₂ set point for lo alarm relay	0 to 100% O ₂
AL2 SETPOINT	% O ₂ set point for hi alarm relay	0 to 100% O ₂
CH2 OUT ZERO	% O ₂ point for 4 mA	0 to 100% O ₂
CH2 OUT SPAN	% O ₂ point for 20 mA	0 to 100% O ₂
AL1 CONFIG	Turn on/off and set alarm 1	OFF, LOW OR HIGH
AL2 CONFIG	Turn on/off and set alarm 2	OFF, LOW OR HIGH

2.7.5 External Compensation Page

COMP 20%	0.50-2.00
COMP 40%	0.50-2.00
COMP 60%	0.50-2.00
COMP 80%	0.50-2.00
COMP 100%	0.50-2.00

Figure 22 External Compensation Page

A 4...20 mA sensor may be used to compensate the % O₂ reading for the effects of process variables such as line pressure, flow, etc. The table of compensation factors may be edited for 5 points along the compensation sensor range. The values would be determined by applying the process variable at each point and noting the effect on the % O₂.

For example: a compensation is needed for line pressure. A 4...20 mA line pressure sensor would be ranged over the compensation range. While the instrument reads a fixed % O₂ value, a table is created (see example below) while varying the pressure at 20% of range intervals:

Pressure	% of Pressure span	O ₂ reading	Effect = (affected value / non affected value)	Compensation factor = 1 / effect
0	0%	20.91	20.91/20.91=1.00	1.00
1	20%	21.65	21.65/20.91=1.04	0.96
2	40%	23.56	1.13	0.88
3	60%	25.99	1.24	0.81
4	80%	29.66	1.42	0.70
5	100%	38.85	1.86	0.54

The compensation factor values are then entered into the External Compensation table (excluding the 0% point as this will always be assumed to be 1 = no effect).

Below 0% (< 4 mA), the compensation factor is fixed to 1. Above 100% the compensation factor is extrapolated beyond the last factor.

2.7.6 External Sensor Page

EXT.SENS PV	tempr
EXT.SENS MIN	-50.0
EXT.SENS MAX	100.0
UNIT	°C

Figure 23 External Sensor Page

This page sets up the type and range of the 4...20 mA external sensor signal that may be connected to the XTP601 for viewing in the Main Page. The range is adjustable between the MIN and MAX values but is not adjustable for **Other** setting (fixed at 0% and 100%).

Setting	Description/Operation	Options
EXT.SENS PV	The process variable that is being measured by the external sensor Select None to turn the feature off Other represents a user-defined variable	None, Dewpoint, tempr, Pressure, Other
EXT.SENS MIN	Depends on parameter and unit settings: Dew point: -100 °C, -148 °F, 173.0 K Temperature: -50 °C, -58 °F, 223.0 K Pressure: 0.0 psia, 0.0 bara, 0.0 kpa Other: 0% (non adjustable)	minimum to EXT.SENS MAX
EX.SENS MAX	Depends on parameter and unit settings: Dew point: 20 °C, 68 °F, 293.0 K Temperature: 100 °C, 212 °F, 373.0 K Pressure: 44.1 psia, 3.0 bara, 304.0 kpa Other: 100% (non adjustable)	EXT.SENS MIN to maximum
UNIT	These are related to the type of sensor selected If Other is selected, then the unit will be a % of the overall range	°C, °F, K, psia, kPa, bara, %

2.7.7 Outputs Page

CH1 TRIM Z	655
CH1 TRIM S	3289
CH2 TRIM Z	649
CH2 TRIM S	3276
CH2 ZERO	0.00 %
CH2 SPAN	100.00 %

Figure 24 OUTPUTS Page

The analyzer has two 4...20 mA outputs and two concentration alarm relays. The primary 4...20 mA is fixed to the calibrated range of the unit, the second is freely selectable from 0 to 100%. The analyzer has the ability to output 4 mA and 20 mA to aid with installation and commissioning. The user is able to trim these outputs via the HMI by highlighting the appropriate channel and using the up and down arrows to adjust the output.

Setting	Description/ Operation	Options
CH1 TRIM Z	Trim 4 mA output on Channel 1	+/- 660
CH1 TRIM S	Trim 20 mA output on Channel 1	+/- 3300
CH2 TRIM Z	Trim 4 mA output on Channel 2	+/- 660
CH2 TRIM S	Trim 20 mA output on Channel 2	+/- 3300
CH2 ZERO	Set 4 mA point for Channel 2	0.00 to 100%
CH2 SPAN	Set 20 mA point for Channel 2	0.00 to 100%

Scroll down past OUTPUTS Page to enter this menu.

2.7.7.1 NAMUR Output Set-Up

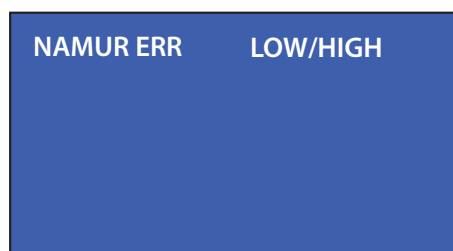

Figure 25 NAMUR ERR Page

During initial warm up, or in the event of a sudden change of cell temperature beyond 0.5 °C from the set point, the mA output will be driven to an alarm state of either 3.5 mA or 21.5 mA. This is to comply with the NAMUR convention and the user can choose either high or low.

Setting	Description/Operation	Options
NAMUR ERR	Will drive mA output high or low if cell temperature is out of tolerance.	Low/High

2.7.8 Field Cal Page

CAL TYPE	1/2 POINT
REF GAS 1	0.00-100.00
ACTUAL 1	0.00-100.00
REF GAS 2	0.00-100.00
ACTUAL 2	0.00-100.00
Adjusted ~	**.**

Figure 26 *Field Cal Page*

Setting	Description/Operation
CAL TYPE	1 POINT or 2 POINT
REF GAS 1	Cal reference gas for 1 point cal, lower cal reference gas for 2 point cal
ACTUAL 1	Actual measured O ₂ for REF GAS 1 See Section 3.1
REF GAS 2	Upper cal reference gas for 2 point cal Disabled if 1 point cal selected
ACTUAL 2	Actual measured O ₂ for REF GAS 2 See Section 3.2 Disabled if 1 point cal selected
ADJUSTED ~	O ₂ reading before and after change ~ symbol will be visible until reading is stable

See Section 3 for field calibration procedure.

2.7.9 Light Guide Option

The light guide is an optional accessory fitted, ideally, to the left hand cable entry and has a red and green LED to display the status.

- Green On – indicates instrument power is on.
- Red LED flashing – indicates when external compensation input or external sensor is out of range (if either is selected to **ON**). Out of range is <3.6 mA or >21 mA (see Status Message Table in Section 2.5.1).
- Red LED On – indicates an internal sensor error or instrument cell temperature not yet stabilized (see Status Message Table in Section 2.5.1) – for LED indication this takes priority over external errors.

These have been designed to follow the NAMUR NE44 standard.

3 CALIBRATION

Factory Calibration:

The unit is factory calibrated at 5 points to maximize the accuracy over the desired range. The calibration generally includes Zero & Span points as well as 3 intermediate points. In the case of suppressed zero ranges then the lowest concentration will replace the Zero Point.

NOTE: Analyzers are calibrated in background gas suitable for the specific application. Customer's calibration gases must match the process gas. Please refer to Test Result Sheet or a Michell Instruments' representative.

For range 0...25% the analyzer will have calibration points between 0 to 21% and will retain specification up to 23% O₂. Concentrations between 23% and 25% O₂ are extrapolated values, unless the operator Field Calibrates (adjusts) the unit with a calibration gas of 25%.

Field Calibration:

Like all process analyzers, the XTP601 will require periodic calibration. The frequency entirely depends on the location, application and accuracy requirements of the user. The typical calibration period is expected to be between 1 and 3 months; however, it is recommended to calibrate the unit at least every 6 months. The user should establish a calibration frequency to ensure that the reading is within the specifications required for the process.

NOTE: It is possible to switch off the Field Calibration and revert to the Factory Calibration. This can be useful for diagnostic purposes if the reading is not what is expected. The unit is delivered with a factory calibration and, as such, would not have any field calibration data. As soon as the first field calibration is performed, the field calibration setting is automatically switched on.

Preparation:

Zero and Span gas cylinders with correct regulation and flow control should be in place before installing and powering up the analyzer. Commissioning should include a check with both gases and, if necessary, a field calibration performed.

The calibration gas applied to the analyzer should be at the same temperature pressure and flow rate as the process gas being sampled.

Sample Pressure: 0.75 to 2 BarA (11 to 29 psiA)

Sample Flow Rate:

GP1 model: 100 to 500 ml/min (0.25 to 1.0 scfh)

EX1 & GP2 Models: 270 to 330ml/min (0.57 to 0.7 scfh)

There are 2 types of field calibration available.

3.1 1-Point Calibration

This is a single point offset overlaid on top of the factory calibration. It is designed to correct minor drift and minor changes during transit. This calibration makes the unit very accurate at the calibration point and improves accuracy throughout the range.

The calibration gas should be of a value that is within the main area of interest, i.e. if main points of interest for a 0-25% range instrument are around the 6% area then apply a calibration gas as close as possible, in the example below we used 6.5% O₂.

1. Apply the calibration gas and purge the unit for at least 5 minutes. View the chart until a flat line shows for 1-2 minutes.

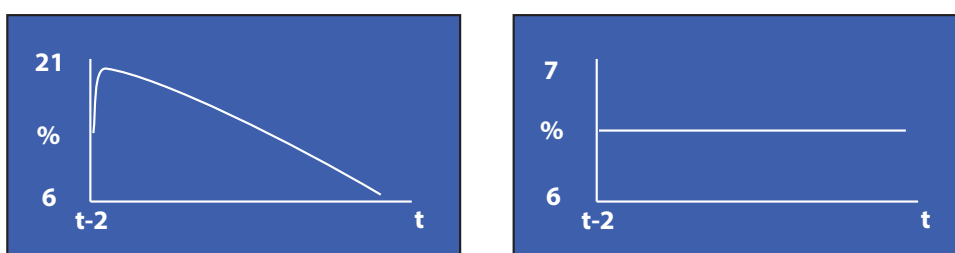

Figure 27 1-Point Calibration Page

2. Press **ENTER** to open the Passcode Page – 1919 Passcode. Navigate to the Field Cal page using the **Up (▲)** button. Press **ENTER** to highlight CAL TYPE and set to 1 POINT. Press **ENTER** to de-select.
3. Press **ENTER** to highlight REF GAS 1 and use the **Up (▲)** and **Down (▼)** buttons to match the value of the concentration of the calibration gas. **NOTE: This value only needs to be set when using a new gas cylinder.** Press **ENTER** to de-select.
4. Ensure the Adjusted value at the bottom of the page has stabilized **NOTE: There will be a ~ symbol next to 'Adjusted' while the reading is stabilizing. When the ~ symbol disappears the reading will be stable and the next change can be made.**
5. Press **ENTER** to highlight ACTUAL 1 value and press the **Up (▲)** button 3 times. Ensure that the Adjusted value equals the REF Gas 1 value ($\pm 0.01\%$). Press **ENTER** to de-select. Press **ESC** to return to the Main Menu.
6. The Adjusted reading will now be the same as that displayed on the Main Page and be equal to the calibration gas.
7. The calibration process is complete. Return to sampling the process gas.

3.2 2-Point Calibration

This is a 2-point adjustment that is overlaid on top of the factory calibration. It is designed to correct minor drift and minor changes during transit. This calibration makes the unit more accurate throughout the range than the single point calibration.

1. Apply the lower calibration gas and purge the unit for at least 5 minutes. View the chart until a flat line shows for 1-2 minutes.

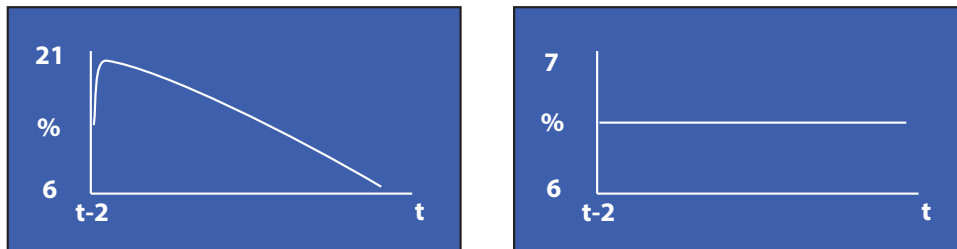

Figure 28 2-Point Calibration Page

2. Press **ENTER** to highlight CAL TYPE and set to 2 POINTS. Press **ENTER** to de-select.
3. Press **ENTER** to highlight REF GAS 1 and use the **Up** (**▲**) and **Down** (**▼**) buttons to match the value of the concentration of the lower calibration gas. **NOTE: This value only needs to be set when using a new gas cylinder.** Press **ENTER** to de-select.
4. Ensure the Adjusted value at the bottom of the page has stabilized **NOTE: There will be a ~ symbol next to 'Adjusted' while the reading is stabilizing. When the ~ symbol disappears the reading will be stable and the next change can be made.**
5. Press **ENTER** to highlight ACTUAL 1 value and press the **Up** (**▲**) button 3 times. Ensure that the Adjusted value equals the REF Gas 1 value ($\pm 0.01\%$). Press **ENTER** to de-select.
6. Apply the upper calibration gas and purge the unit for at least 5 minutes. View the chart until a flat line shows for 1-2 minutes (see above).
7. Press **ENTER** to highlight REF GAS 2 and use the **Up** (**▲**) and **Down** (**▼**) buttons to match the value of the concentration of the upper calibration gas. **NOTE: This value only needs to be set when using a new gas cylinder.** Press **ENTER** to de-select.
8. Ensure that the Adjusted value at the bottom of the page has stabilized.
9. Press **ENTER** to highlight ACTUAL 2 value and press the **Up** (**▲**) button 3 times. Ensure that the Adjusted value now equals REF Gas 2 value ($\pm 0.01\%$). Press **ENTER** to de-select. Press **ESC** to return to the Main Menu.

10. The Adjusted reading will now be the same as that displayed on the Main Page and be equal to the upper calibration gas.
11. The calibration process is complete. Return to sampling the process gas.

NOTE: The analyzers leave the factory with the field calibration function turned off. When first calibrating the analyzer go to the settings page and turn Field Calibration on. This can be done either just before or just after the field calibration procedure.

3.3 Field Calibration Reset

The Field Calibration can simply be turned ON or OFF in the settings page. But if the user would like to start again, the Field Cal (including saved data) can be deleted in this menu.

This feature is accessed by selecting the Reset Page (see below).

O2 MIN/MAX	RESET?
ALARM LOGS	DELETE?
FIELD CAL	DELETE?

Figure 29 *Field Calibration Reset Page*

Select Field Calibration and highlight **DELETE?**, then press the **Up (▲)** button 3 times and then press **ENTER** to accept the change.

4 INSTALLATION

Before installing the analyzer, read through this manual carefully and take note of all warnings.



The XTP601-EX versions must only be installed by suitably qualified personnel and in accordance with the instructions provided and the terms of the applicable product certificates.

Maintenance and servicing of the product must only be carried out by suitably trained personnel or returned to an approved Michell Instruments' Service Center.



Before the cover is refitted, the flamepath/threaded joint between the cover and body must be thoroughly wiped clean of dirt, grit or other foreign substances and then a thin coating of an approved form of non-setting grease applied to joint/threads. Ensure gasket is free from damage.

Threaded covers must be screwed on to a minimum of 7 full threads and then locked in position with the hex key provided.



The terms of the Hazardous Area Certification do not permit oxygen measurement in ambient areas with enriched oxygen.

4.1 Unpacking

If sold separately (not part of a sampling system), the XTP601 will be supplied in a custom box which should be retained for future use (such as service return). The box contains a small carton containing 2 lid keys and 1 hex key (for the grub screw). Any cable glands supplied will also be in the smaller carton.

Contents:

- XTP601 Process Oxygen Analyzer
- Test result sheet
- Carton (containing: 2 x lid keys, 1 x hex key and 1 x main pcb fuse.)
- Cable glands (if ordered)
- 97327 – Product quick-start sheet (for GP versions only)
- 97297 – Hazardous Area requirement sheet (for EX versions only)

4.2 System Components

The XTP601 Oxygen Analyzer benefits from a modular construction, with the major parts of the analyzer shown below:

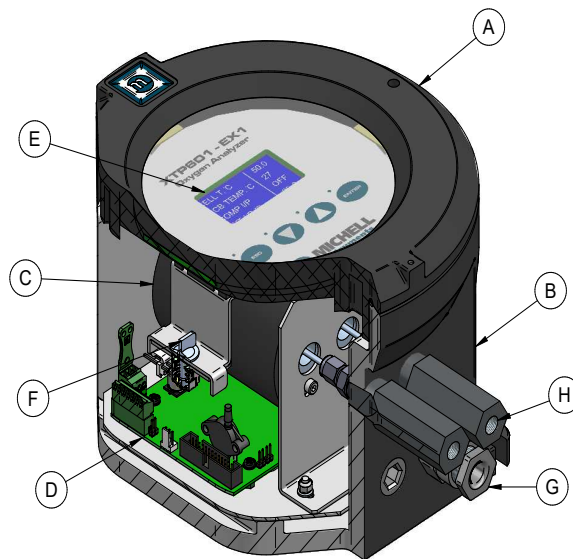

Figure 30 XTP601 Cutaway Showing Major Components

- A Lid with display and touch screen
- B Instrument case
- C Measuring cell
- D Motherboard
- E Display PCB
- F Quick release mechanism for display PCB
- G Cable/Conduit entries (3 available)
- H Gas Inlet (left hand side) / Outlet (right hand side)

4.3 Set-Up

- The XTP601 is designed to be panel or wall mounted. There are 2 bolt holes and 2 lugs (1 per corner) see Figure 11. Dimensional drawings can be found in Appendix A.1. Mount the analyzer before attempting to remove the lid.



WARNING: This unit is 24 V DC powered only! Do not attempt to loop-power this instrument via the 4...20 mA output as this will irreversibly damage the main pcb.

- The EXd thread is greased and therefore it may be advisable to wear latex gloves.
- Ensure that the grub screw is loose, using the hex key (supplied), to prevent scoring on the casing.
- Connect the earthing strap to the earth point on the right hand side of the case.
- Remove the lid, using the lid keys (supplied). The lid will require a firm grip to loosen.

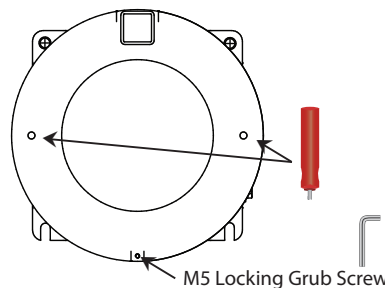

Figure 31 XTP601 Lid Removal

- If fitted, remove the display / status pcb via the two ¼ turn quick-connect fittings.
- Disconnect the ribbon / interconnecting cable from the loose pcb.



WARNING: Prior to connecting power, ensure the unit is correctly earthed via the earth point on the right hand side of the case.

- Connect to the power and outputs (see Section 4.5).
- After making all necessary connections, reconnect the pcb via the ribbon/ interconnecting cable & quick-connect fittings and replace the lid, ensuring at least 7 full turns on the thread to complete the gas path.
- Use the hex key (supplied) to tighten the grub screw. **NOTE: This is necessary in order to adhere to the hazardous area certification requirements.**
- For operating instructions refer to Section 2.

4.4 Mechanical Installation

There are 3 cable entries on the bottom surface, towards the rear, that can be utilized by the customer in a variety of manners. The following standard options are available: Cable Gland, Conduit Entry, Blanking Plug or Light Guide.

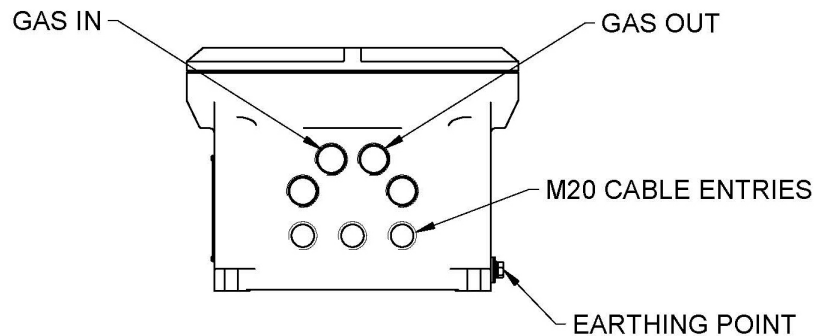

Figure 32 XTP601 Cable Entries

4.4.1 Gas Connection

The gas connections are on the bottom surface towards the front of the unit. The gas inlet is the left hand connection when viewing the unit from the front. The GP1 model has 1/4" NPT female and EX1 & GP2 models have 1/8" NPT female gas connections.



For applications where the oxygen concentration is 90% or above, any PTFE tape used must be unsintered. This is to prevent an explosion due to conventional PTFE tape acting as a potential fuel source.

Unsintered PTFE tape is available as an accessory from Michell Instruments (PTFE-TAPE-02).

4.4.2 Sample Gas Requirements

This analyzer must have a constant sample temperature, pressure and flow rate to remain within its stated specification. Furthermore, the calibration gas (ideally certified gas) should be introduced to the analyzer in a manner matching the process conditions.

Samples must have a dew point at least 10 °C less than the cell temperature (so as not to condense), be free from oil-mist and with particle size < 3µm. **NOTE: There is NO filtration inside the analyzer.**

Sample Pressure:

- 0.75 to 2 BarA (11 to 29 psiA)

Sample Flow Rate:

GP1 model: 100 to 500 ml/min (0.25 to 1.0 scfh)

EX1 & GP2 models: 270 to 330ml/min (0.57 to 0.7 scfh)

Ideally a flowmeter and needle valve would be placed in front of the analyzer and the vent would be open to the atmosphere.

4.4.3 Calibration Gases

Cylinders of the appropriate Zero and Span gases should be available for installation and commissioning. Dependent on the specific duty of the analyzer, these gases may have a lead time of several weeks. See Section 3 for more information.

If you are having difficulty in finding a local gas supplier, please contact your local Michell representative for assistance.

4.5 Electrical Installation

4.5.1 Power Supply and Input/Output Signal

The XTP601 requires 24 V DC power input at a maximum start-up current of 1.5 A.

All versions will use a braid screened multi-core cable. Ideally, one cable for signals (PL4, PL5) and another cable for power (PL9) / relay contacts (PL1). Braid of cables must be well terminated at the cable glands. Wire sizes should be between 28 and 16 AWG.

The terminal blocks for the power supply, input signal and output signal are located underneath the lower PCB. **NOTE: The terminal blocks are color co-ordinated to match the connectors – make sure this color coding is adhered to.**

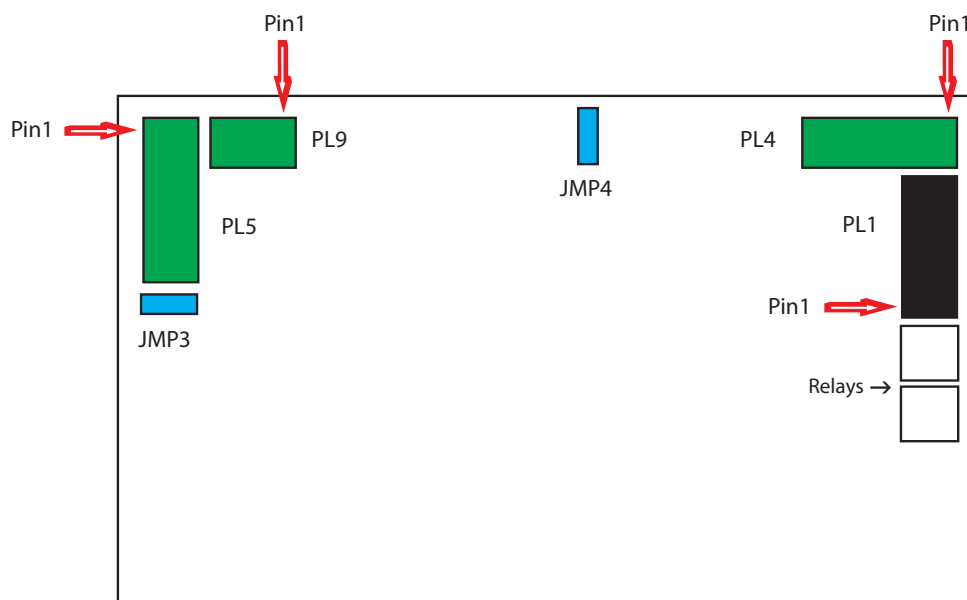

Figure 33 Terminal Block Locations

4.5.2 Power Supply (PL9 – Green)

PIN 3	PIN 2	PIN 1
0 V	N/C	24 V \pm 4 V

4.5.3 Signal Output

There are two 4...20mA linear signal output channels. Both are for oxygen concentration. One is fixed on the calibrated range of the unit and the second can be configured in the menu. **NOTE: When the instrument is warming up (cell temperature not stabilized) these outputs are factory set to 3.2 mA to indicate that the instrument is not ready.**

- The maximum mA output is approximately 20.5mA
- The minimum mA output is approximately 3.8mA
- The user can select the fault condition to drive the mA output Low (3.2mA) or Hi (21.4mA).

4.5.4 Serial Output

The analyzer has Modbus RTU communications over RS485.

- Type: Modbus RTU over RS485
- RS485: 2 wire (plus ground), half duplex
- Baud Rate: 9600
- Parity: None
- Data bits: 8
- Stop bits: 1

4.5.5 Analog (4...20 mA) Outputs and Communications (PL5 – Green)



Warning: Do not attempt to loop-power this instrument via the 4...20 mA output as this will irreversibly damage the main PCB.

PIN 7	PIN 6	PIN 5	PIN 4	PIN 3	PIN 2	PIN 1
RS485 GND	RS485 B	RS485 A	Ch2 O/P -	Ch2 O/P +	Ch1 O/P -	Ch1 O/P +

NOTE 1: Channel 1 is fixed range output over instrument range and Channel 2 is adjustable between 0-100%.

NOTE 2: For long cable lengths, a termination resistor of 120Ω is provided to aid in impedance matching of the communications cable. This is selectable via JMP3. A terminating resistor is simply a resistor placed at the extreme end or ends of a cable on an RS485 network to reduce effects of impedance mismatch. Impedance mismatch can cause reflections of data as it passes down the cable and the reflections could be large enough to cause data errors.

NOTE 3: The maximum loop load resistance for mA outputs is 550Ω

4.5.6 Alarm Relay Contacts (PL1 – Black)

AL2			AL1		
PIN 6	PIN 5	PIN 4	PIN 3	PIN 2	PIN 1
Alarm 2 C	Alarm 2 NO	Alarm 2 NC	Alarm 1 C	Alarm 1 NO	Alarm 1 NC

- Type: SPCO (NO, NC and C)
- Contact Rating, Max: 2 A, 250 V AC
- Hysteresis is 0.03% O₂
- AL1 and AL2 can be configured as OFF, LOW or HIGH
- A low alarm switches on when % O₂ is below the set point and switches off when % O₂ is above the set point + Hysteresis
- A high alarm switches on when % O₂ is above the set point and switches off when % O₂ is below the set point – Hysteresis
- When the instrument is warming up (cell temperature not stabilized) both relays are OFF

4.5.7 Analog (4...20 mA) Inputs and Sensor Excitation Voltage (PL4 – Green)

PIN 6	PIN 5	PIN 4	PIN 3	PIN 2	PIN 1
Ch2 I/P -	Ch2 I/P +	Ch2 Exc.V	Ch1 I/P -	Ch1 I/P +	Ch1 Exc.V

The XTP601 features 2 input channels for 4...20 mA signal from external instruments such as pressure transmitters or other devices to compensate for pressure or background gas influence.

The input configured as **EXT SENS** (External Sensor) can be viewed on the Secondary Parameters Page under the heading **EXT I/P** (External Input).

NOTE 1: Channel 1 is External Compensation input and Channel 2 is External Sensor input.

NOTE 2: Excitation voltage = Same as power supply ± 1 V if JMP4 connected across top 2 pins and 15 ± 0.5 V (max 100 mA per channel) if JMP4 connected across bottom 2 pins.

4.5.8 Light Guide

The optional light guide can be fitted to the left hand cable entry. If this is required for the Hazardous Area version of the analyzer this must be specified at time of purchase order.



If fitted in a Hazardous Area (EX) version of the XTP601 the light guide not be dismantled by the user. Dismantling the Light Guide will invalidate the the certification.

NOTE: Only 1 light guide can be fitted to each analyzer.

Appendix A

Technical Specifications

Appendix A Technical Specifications

Performance	
Measurement Technology	Thermo-paramagnetic oxygen sensor
Gas	Process and non-condensing sample with particles <5 µm
Measurement Range	Select from 0-0.5% up to 0-50% and 20-100% up to 90-100%
Display Resolution	0.01% for zero based ranges 0.1% for suppressed zero ranges
Display Type	Backlit LCD
Accuracy (excluding suppressed zero ranges)	±0.02% O ₂ or <±1% of reading; whichever is greater
Accuracy (for suppressed zero ranges 20/80/90-100%)	±0.2% O ₂ or < ±1% of range; whichever is greater
Response Time (T90) with HSR enabled	< 15 seconds
Repeatability	±0.2% of range or 0.02% O ₂ ; whichever is greater
Linearity	±0.5% of range or 0.05% O ₂ ; whichever is greater
Zero Stability	±0.25% of range per month
Range Stability	±0.25% of range per month
Sample Flow Rate *	GP1: 100...500 ml/min (0.25...1.0 scfh) EX1 and GP2: 270...330 ml/min (0.57...0.7 scfh)
Sample Pressure *	0.75...2 BarA (11...29 psiA)
Sample Temperature *	5...55 °C (+41...+122 °F) max (+45 °C (+113 °F) for standard cell)
Sample Cell Temperature	Standard +50 °C (+113 °F) (Optional +55 °C and +60 °C (+131 °F and +140 °F) for selected ranges and gases)
Background Gas	Analyzer is calibrated in the background gas of the process. Standard gases are: N ₂ , CO ₂ , CH ₄ , H ₂ & Biogas. Others available on request.
Electrical Input/Output	
Analog Inputs	1 off mA input for an external sensor (can be displayed on the screen) 1 off mA input to act as an active compensation for the process conditions
Analog Outputs	2 off 4...20 mA outputs (powered with 24V excitation voltage)
Output Ranges	Primary range is set to the calibrated range of the instrument The second is user configurable between 0-100%
Alarms	2 off single pole changeover (SPCO) relays for O ₂ concentration (250 V, 5 A max)
Datalogging	The user can use the digital communications to log the output from the analyzer The unit will store 40 alarm points and the min/max O ₂ concentrations with date and time stamp
Digital Communications	Modbus RTU over RS485
Power Supply	24 V DC; 1.5 A max
Cable Entries	Analyzer is supplied with 3 x M20 cable entries. Cable glands, conduit entries and blanking plugs are available as accessories.

Operating Conditions	
Ambient Temperature	5 °C...+60 °C (+41 °F...+140 °F)
Atmospheric Pressure	750 mbar...1250 mbar
Mechanical Specification	
Warm Up Time	< 25 minutes
Stabilization Time	5 minutes
Dimensions	234 x 234 x 172 mm (9.2 x 9.2 x 6.7") (w x d x h)
Weight	9.7 kg (21.4 lbs)
Wetted Materials	316 & 430F stainless steel, borosilicate glass, platinum, 3M 2216 plus O-ring
O-Ring Materials	Viton, Silicone or Ekraz
Gas Connection	EX1 & GP2: 1/8" NPT (female) GP1: 1/4" NPT (female)
Ingress Protection	IP66, NEMA 4X
Hazardous Area Certification (see Appendix C)	
Temperature Ranges as per O-Ring type	Silicone: Ta = -40...+55 °C Viton: Ta = -15...+55 °C Ekraz: Ta = -10...+55 °C

The XTP601 process oxygen analyzer meets or exceeds all relevant clauses in BS EN 50104 : 2010 "Electrical apparatus for the detection and measurement of oxygen".

* This analyzer must have a constant sample temperature, pressure and flow rate to remain within its stated specification. Furthermore, the calibration gas (ideally certified gas) should be introduced to the the analyzer in a manner matching the process conditions.

A.1 Dimensions Ex version

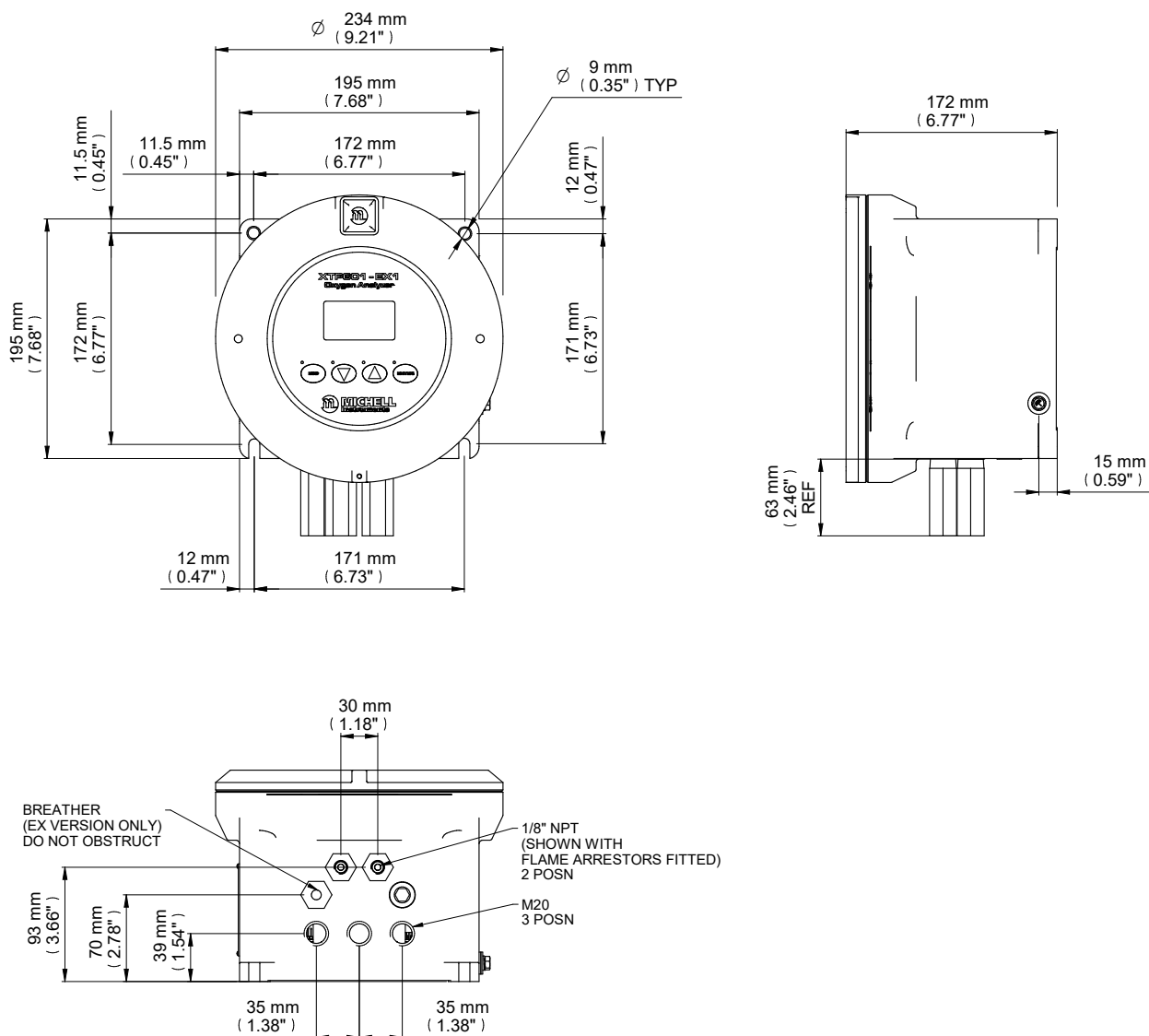

NOTE 1: The GP1 model has 1/4" NPT female gas connections.
EX1 and GP2 models have 1/8" NPT female gas connections.

NOTE 2: Fixing mounts are NOT symmetrical.
This is to ensure correct orientation.

Figure 34 XTP601 Dimensional Drawings

Appendix B

Modbus Register Map

Appendix B Modbus Register Map

Compatible with XTP601 Firmware Version: V1:11

Addr	Function	Access	Ranges/Resolution	Type
0	Modbus Instrument Address (ID)	R/W	1...127	A
1	Settings Register	R/W	0...65535	B
2	Display Contrast / Brightness	R/W	0...100% / 0...100%, 10% steps	C
3	Units Register(Temp, Pressure, Ext Sens Param etc)	R/W	See reg details	D
4	Chart Interval	R/W	2...60 Sec, in 2 sec intervals	A
5	Background Gas Index	R/W	0...23	A
6	Alarm 1 (Lo alarm) Set point	R/W	Instrum range min Instrum range max, 0.01	G
7	Alarm 2 (Hi alarm) Set point	R/W	Instrum range min Instrum range max, 0.01	G
8	O ₂ Range Zero (Ch1 output zero)	R	0.00 to O ₂ Range Span	G
9	O ₂ Range Span (Ch1 output span)	R	O ₂ Range Zero to 100.00	G
10	CH1 comp coefficient 20%	R/W	0.50...2.00	G
11	CH1 comp coefficient 40%	R/W	0.50...2.00	G
12	CH1 comp coefficient 60%	R/W	0.50...2.00	G
13	CH1 comp coefficient 80%	R/W	0.50...2.00	G
14	CH1 comp coefficient 100%	R/W	0.50...2.00	G
20	CH2 Input (Ext Sensor) zero	R/W	See Reg Details	F
21	CH2 Input (Ext Sensor) span	R/W	See Reg Details	F
22	Alarm / NAMUR Configuration	R/W	See Reg Details	L
23	Cell Temp Set point	R	40...70 C	A
29	O ₂ Field Cal Reference 1	R/W	0.00% or (min -20% for suppressed Zero) to max + 20% of Instrument Range, 0.01	G
30	O ₂ Filed Cal Actual 1	R/W	-199.99...199.99	G
31	O ₂ Field Cal Reference 2	R/W	Instrument Range min to (max + 20% of range), 0.01	G
32	Pressure at calibration	R	800.0...1200.0 mBar	F
37	O ₂ Field Cal Actual 2	R/W	-199.99...199.99	G
56	CH2 output zero	R/W	Instrument range min to CH2 output span, 0.01	G
57	CH2 output span	R/W	CH2 output zero to instrument range max, 0.01	G
63	Hours Of Operation	R	0...65535	A
65	Set Clock HRS	W	00...23	J
66	Set Clock MIN	W	00...59	J
67	Set Clock DAY	W	01...31	J
68	Set Clock MONTH	W	01...12	J
69	Set Clock YEAR	W	00...99	J
70	%O ₂ without HSR	R	-199.00...199.99%	G
71	%O ₂ with HSR	R	-199.00...199.99%	G
72	Cell Temperature	R	-99.9...99.9 or equiv in F or K	F
73	PCB temperature (from MSP)	R	-99 to 99 C or equiv in F or K	K
74	Atmos pressure	R	0...1500mBar	A

Addr	Function	Access	Ranges/Resolution	Type
75	mA1 Input in % (comp signal)	R	0.0...100.0 %	F
76	mA2 Input (ext sensor signal)	R	See Reg Details	F
77	Status Flags register	R	0...65535	I
78	Clock HOURS/MIN	R	00...23 / 00...59	J
79	Clock SEC/DAY	R	00...59 / 01...31	J
80	Clock MONTH/YEAR	R	01...12 / 00...99	J
81	%O ₂ MINIMUM (stats)	R	-199.00...199.99%	G
82	%O ₂ MAXIMUM (stats)	R	-199.00...199.99%	G
84	Firmware Version	R	0.00...200.00	G
91	%O ₂ without field cal correction	R	-199.00...199.99%	G

Register Type A: Unsigned Integer

15	14	13	12	11	10	9	8	7	6	5	4	3	2	1	0
r/w	r/w	r/w	r/w	r/w	r/w	r/w	r/w	r/w	r/w	r/w	r/w	r/w	r/w	r/w	r/w

Unsigned integer. Range = 0 to 65535

Background Gas list:

Air	C3H6	He	NO
Ar	C4H6	Kr	O2
BioG	CH4	N2	SF6
C2H4	CO2	N2O	SynG
C2H6	CO	Ne	Xe
C3H8	H2	NH3	XXXX (not defined)

Register Type B: Settings

15	14	13	12	11	10	9	8	7	6	5	4	3	2	1	0
r/w	r/w	r/w	r/w	r/w	r/w	r/w	r/w	r/w	r/w	r/w	r/w	r/w	r/w	r/w	r/w

Bit	HEX	Meaning
0	0001	Field Cal On
1	0002	Pressure Compensation On
2	0004	External Compensation On
3	0008	Background Gas Compensation On
4	0010	HSR On
5	0020	Display Limit 0...100% On

Register Type C: Display Parameters

15	14	13	12	11	10	9	8	7	6	5	4	3	2	1	0
Display Brightness								Display Contrast							
r/w	r/w	r/w	r/w	r/w	r/w	r/w	r/w	r/w	r/w	r/w	r/w	r/w	r/w	r/w	r/w
0...100 in 10% steps								0...100 in 10% steps							

Register Type D: Units

15	14	13	12	11	10	9	8	7	6	5	4	3	2	1	0
r/w	r/w	r/w	r/w	r/w	r/w	r/w	r/w	r/w	r/w	r/w	r/w	r/w	r/w	r/w	r/w

Bits	HEX	Meaning (binary)
0, 1	0003	00=°C, 01=°F, 10=K
2, 3	000C	Ext press unit, 00 = psia, 01=bara, 10=kPa
4	0010	Field cal type, 0=1 gas (offset), 1=2 gas
5	0020	Date format 0=Non US, 1=US
11,12,13	3800	Ext Sensor Parameter (000=none, 001=dewp, 010=temp, 011=press, 100=other)

Register Type F: -2000.0 to +2000.0

15	14	13	12	11	10	9	8	7	6	5	4	3	2	1	0
r/w	r/w	r/w	r/w	r/w	r/w	r/w	r/w	r/w	r/w	r/w	r/w	r/w	r/w	r/w	r/w

Range = 0 to 40000 represents -2000.0 to +2000.0

Conversion: (RegValue – 20000)/10.0

For external sensor values

Dew point: -100/+20 °C, -148.0/+68.0 °C, 173.0/293.0 K

Temp: -50.0/+100.0 °C, -58.0/+212.0 °F, 223.0/373.0 K

Pressure: 0.0/44.1 psia, 0.0/3.0 barA, 0.0/304.0 kpa

Register Type G: -200.00 to +200.00

15	14	13	12	11	10	9	8	7	6	5	4	3	2	1	0
r/w	r/w	r/w	r/w	r/w	r/w	r/w	r/w	r/w	r/w	r/w	r/w	r/w	r/w	r/w	r/w

Range = 0 to 40000 represents -200.00 to +200.00

Conversion: (RegValue – 20000)/100.00

Register Type I – Status/Error

15	14	13	12	11	10	9	8	7	6	5	4	3	2	1	0
r	r	r	r	r	r	r	r	r	r	r	r	r	r	r	r

Bit	HEX	Meaning	Namur LED
0	0001	Displays O ₂ HSR or O ₂ depending on setting (system)	N/A
1	0002	%O ₂ out of range (beyond calibration range, e.g. 0...25%)	N/A
2	0004	Low alarm ON	YELLOW 1 ON
3	0008	High alarm ON	YELLOW 2 ON
4	0010	Ext Comp i/p signal error (input < 3.6mA or > 21mA)	RED FLASH (priority2)
5	0020	Ext sens. signal error (input < 3.6mA or > 21mA)	RED FLASH (priority2)
6	0040	Cell T not stable (not within +/- 0.15 °C of setpoint for continuous period of 15 minutes)	RED ON (priority1)
7	0080	Cell T sensor error (cell tempr measures <-50 or >80 °C)	RED ON (priority1)
8	0100	Press sensor error (Press sensor < 700 or >1300 mbar)	RED ON (priority1)
9	0200	O ₂ sensor error (Vcomp <=1 or >=8191)	RED ON (priority1)
10	0400	PCB tempr too high (PCB tempr > Cell tempr setpoint)	RED ON (priority1)

Register Type J

15	14	13	12	11	10	9	8	7	6	5	4	3	2	1	0
r/w	r/w	r/w	r/w	r/w	r/w	r/w	r/w	r/w	r/w	r/w	r/w	r/w	r/w	r/w	r/w

←────────────────── eg Day ───────────────────▶ ←────────────────── eg Month ───────────────────▶

For reading each 8 bits represents a RTC value. For setting only the Lower 8 bits are used for each RTC value.

Register Type K: -32767 to +32767

15	14	13	12	11	10	9	8	7	6	5	4	3	2	1	0
r/w	r/w	r/w	r/w	r/w	r/w	r/w	r/w	r/w	r/w	r/w	r/w	r/w	r/w	r/w	r/w

Range = 0 to 65535 represents values
 Conversion: (RegValue – 32767)

Register Type L: Alarm/NAMUR Configuration

15	14	13	12	11	10	9	8	7	6	5	4	3	2	1	0
r/w	r/w	r/w	r/w	r/w	r/w	r/w	r/w	r/w	r/w	r/w	r/w	r/w	r/w	r/w	r/w

Bits	Meaning
1, 0	00 = Alarm1 is Inactive (off) 01 = Alarm1 is a Low Alarm 10 = Alarm1 is a High Alarm
3, 2	00 = Alarm2 is Inactive (off) 01 = Alarm2 is a Low Alarm 10 = Alarm2 is a High Alarm
4	0 = Namur Error Level Low (3.2mA) 1 = Namur Error Level High (21.4mA)

Appendix C

Hazardous Area Certification

Appendix C Hazardous Area Certification

The XTP601-EX Oxygen Analyzer is certified compliant to the ATEX Directive (2014/34/EU), the IECEx scheme and SI 2016 No. 1107 UKCA product marking scheme for use within Zone 1 & 2 Hazardous Areas and has been assessed as being so by CML BV Netherlands (Notified Body 2776) and EUROFINS CML UK (Approved Body 2503).

The XTP601-EX Oxygen Analyzer is certified compliant to the applicable North American Standards (USA and Canada) for use within Class I, Division 1 and Class I, Zone 1 Hazardous Locations and has been assessed as being so by QPS Evaluation Services Inc.

C.1 Product Standards

This product conforms to the Standards:

BS/EN60079-0:2018	CSA C22.2 No. 60079-1-16
BS/EN60079-1:2014	CSA C22.2 No. 61010-1-12
EN60079-31:2014	ANSI/UL 60079-0 7th ed.
IEC60079-0:2017	ANSI/UL 60079-1 7th ed.
IEC60079-1:2014	ANSI/UL 61010-1, 3rd ed.
IEC60079-31:2013	FM 3600-2018
CSA C22.2 No. 30-1986	FM 3615-2018
CSA C22.2 No. 60079-0-19	FM 3810-2018

C.2 Product Standards

This product is attributed with the product certification codes:

ATEX, UKCA & IECEx	North American:
II 2 GD Ex d IIB+H2 T6 Gb	Class I, Division 1, Groups B, C and D, T6
Ex tb IIIC 85 °C Db IP66	Class I, Zone 1 AEx db IIB+H2 T6 Gb
	Ex db IIB+H2 T6 Gb
Silicone: Ta = -40 °C...+60 °C	Silicone: Ta = -40 °C...+50 °C
Viton: Ta = -15 °C...+60 °C	Viton: Ta = -15 °C...+50 °C
Ekraz: Ta = 10 °C...+60 °C	Ekraz: Ta = 10 °C...+50 °C

C.3 Global Certificates/Approvals

ATEX	CML 20ATEX1038X
IECEX	IECEX CML 20.0018X
UKCA	CML UKEX21.1048X
cQPSus	LR1507-6

These certificates can be viewed or downloaded from our websites at:
www.processsensing.com & www.michell.com

C.4 Special Conditions

1. Cable entry holes shall be fitted with either an appropriately certified cable gland or appropriate certified blanking element. These shall provide and maintain a minimum enclosure ingress protection of IP66.
2. The maximum pressure associated with the process medium in the internal pipes shall be limited to 1 bar.
3. The maximum temperature associated with the process medium shall be limited to 60 °C.
4. The flameproof joints of the flame arrestors & breather are not intended to be repaired.

C.5 Maintenance and Installation

The XTP601-EX must only be installed by suitably qualified personnel and in accordance with the instructions provided and the terms of the applicable product certificates.

Maintenance and servicing of the product must only be carried out by suitably trained personnel or returned to an approved Michell Instruments Service Center.

Flame paths are not intended to be repaired.

Appendix D

Quality, Recycling, Compliance & Warranty Information

Appendix D Quality, Recycling, Compliance & Warranty Information

Michell Instruments is dedicated to complying to all relevant legislation and directives. Full information can be found on our website at:

www.michell.com/compliance

This page contains information on the following directives:

- Anti-Facilitation of Tax Evasion Policy
- ATEX Directive
- Calibration Facilities
- Conflict Minerals
- FCC Statement
- Manufacturing Quality
- Modern Slavery Statement
- Pressure Equipment Directive
- REACH
- RoHS3
- WEEE2
- Recycling Policy
- Warranty and Returns

This information is also available in PDF format.

Appendix E

Analyzer Return Document & Decontamination Declaration

Appendix E Analyzer Return Document & Decontamination Declaration

Decontamination Certificate

IMPORTANT NOTE: Please complete this form prior to this instrument, or any components, leaving your site and being returned to us, or, where applicable, prior to any work being carried out by a Michell engineer at your site.

Instrument			Serial Number	
Warranty Repair?	YES	NO	Original PO #	
Company Name			Contact Name	
Address				
Telephone #			E-mail address	
Reason for Return /Description of Fault:				
Has this equipment been exposed (internally or externally) to any of the following? Please circle (YES/NO) as applicable and provide details below				
Biohazards			YES	NO
Biological agents			YES	NO
Hazardous chemicals			YES	NO
Radioactive substances			YES	NO
Other hazards			YES	NO
Please provide details of any hazardous materials used with this equipment as indicated above (use continuation sheet if necessary)				
Your method of cleaning/decontamination				
Has the equipment been cleaned and decontaminated?			YES	NOT NECESSARY
Michell Instruments will not accept instruments that have been exposed to toxins, radio-activity or bio-hazardous materials. For most applications involving solvents, acidic, basic, flammable or toxic gases a simple purge with dry gas (dew point <-30°C) over 24 hours should be sufficient to decontaminate the unit prior to return. Work will not be carried out on any unit that does not have a completed decontamination declaration.				
Decontamination Declaration				
I declare that the information above is true and complete to the best of my knowledge, and it is safe for Michell personnel to service or repair the returned instrument.				
Name (Print)			Position	
Signature			Date	



F0121, Issue 2, December 2011

NOTES

www.ProcessSensing.com



<http://www.michell.com>